

RESEARCH ARTICLE



Aquaponics for Trinidad and Tobago: Advancing Sustainable Farming for Low-Carbon Economy

Don Charles^{1,*}

¹Independent Researcher, Trinidad and Tobago

Abstract: Trinidad and Tobago (T&T) is a net importer of food. Thus, the country is vulnerable to high food prices, high food imports, and food insecurity. These problems can be addressed through the development of the aquaponics industry locally. Moreover, aquaponics offers a sustainable solution as it encourages the conservation of water and eliminates the need for synthetic fertilizer, which generates high greenhouse gas emissions in its production process. The objectives of this study are to analyze and forecast T&T's food imports and to examine the technical and economic policy requirements for the aquaponics industry in T&T. An empirical mode decomposition-artificial neural network forecast of T&T's food imports suggests that T&T's food imports will increase, and by month 12 it will be TT \$1,224,329,616.27. With regard to the economic framework, the major obstacle to the development of T&T's aquaponics industry appears to be the upfront costs. To establish a professional aquaponics farm that maintains supplies of fish and plant produce, the farmer must incur an upfront capital cost. If the cost of the greenhouse is included, it can take a farmer up to 6 years to recover this cost before they earn a profit. Therefore, government support is required to alleviate this cost burden for farmers.

Keywords: aquaponics, sustainable agriculture, low-carbon agriculture, economic evaluation, EMD-ANN, Trinidad and Tobago

1. Introduction

Trinidad and Tobago (T&T) is a net importer of food. External macroeconomic factors that cause a rise in food prices tend to result in T&T importing inflation. A visual inspection of T&T's food retail price index (RPI) and T&T's food and beverage imports displays a positive association (see Figure 1).

Indeed, a policy response is required to address elevated food prices, high food imports, and food security. An increase in the supply of domestically produced food can address all the aforementioned concerns. In fact, the CARICOM Heads of Governments have recognized this, and they intend to achieve their target of reducing the region's food import bill by 25% by the year 2025 increasing the production of food [3]. This will require each CARICOM Member State to increase its domestic production of food.

Notably, T&T, like its neighboring CARICOM island states, has a small land mass. Trinidad has an area of 4768 km² while Tobago has an area of about 363 km², combining for a total land area of 5131 km² [4]. Additionally, there is strong competition for land use, as many stakeholders seek land for residential and commercial purposes. Therefore, any strategy to boost agriculture output in T&T must consider this land constraint. In this regard, aquaponics emerges as a potential solution.

Aquaponics is an attractive sustainable farming technique. It can be used to address food security, mitigate against high food import prices, reduce the demand for food imports, facilitate the saving of foreign exchange, generate employment and income-earning opportunities, and help countries transition to a low-carbon economy.

The objectives of this study are twofold. First, this study seeks to analyze and forecast T&T's food imports. This is important because, despite the existence of several incentives, T&T's food imports seem to be rising. A robust econometric analysis of T&T's food imports will statistically verify or refute this.

Second, this study seeks to develop a policy response to address T&T's food imports. More specifically, this study proposes the aquaponics industry as a means to address and curb T&T's food imports. Therefore, this study examines the technical and economic policy requirements for an aquaponics industry in T&T. Notably, the findings of this study can be applied to any small island developing state seeking to achieve food security while transitioning to the low-carbon economy.

The rest of this study is structured as follows. Section 2 provides a literature review of T&T's agriculture industry. Section 3 provides a methodology to analyze T&T's food imports. Section 4 presents the results and forecasts of T&T's food imports. This is important as it shows T&T's agriculture outlook in a business-as-usual situation. This provides justification for new policy intervention to change the outlook. Section 5 examines the technical and economic aspects of aquaponics as it is anticipated as the policy response to the problem. Section 6 concludes this study.

*Corresponding author: Don Charles, Independent Researcher, Trinidad and Tobago. Email: don.charles@my.uwi.edu

2. Literature Review

2.1. T&T’s agriculture industry and food imports

The colonial past of T&T has influenced the country’s agricultural sector. When T&T was under colonial administration, it focused on producing and exporting primary agriculture commodities, namely sugar, cocoa, coffee, and citrus fruit. The main market for the exports was the United Kingdom (UK), and sugar was the dominant cash crop [5].

There were more than 300 sugar plantations in Trinidad during the 1880s. The country’s agriculture model was twofold, where there were a few large plantations that specialized in the cultivation of crops for export, and several small farms, on plots less than 5 acres, which produced a wide variety of crops for families and the domestic market [6].

After T&T achieved independence in 1962, sugar remained an important cash crop. By 1975, the government-owned sugar company (Caroni (1975) Limited) operated on approximately 77,000 acres of land and was labor-intensive as it employed over 9000 workers. Furthermore, there were approximately 6000 additional independent sugarcane farmers operating in the country [6]. Certainly, the 1970s marked the peak of the agriculture industry in T&T.

T&T gradually experienced an erosion of trade preferences in the agriculture industry. Furthermore, the government was more interested in the hydrocarbon industry. Natural gas exports from the Atlantic liquefied natural gas (LNG) consortium started in 1999, and by the 2000s the government was earning flamboyant LNG revenues [7]. Subsequently, when Caroni (1975) Limited was incurring losses in the early 2000s, the government shut down the company. This had a multiplier effect which triggered the exodus of several people from the agriculture industry, resulting in a decline in T&T’s agriculture output.

Over the next 2 decades, the Government of the Republic of Trinidad and Tobago (GORTT)’s efforts to revive the agriculture industry could be described as dormant. Primary agriculture output declined while T&T’s food imports increased.

In 2020, the World Health Organization (WHO) declared COVID-19 a pandemic, and the GORTT implemented a series of non-pharmaceutical measures to contain the transmission of the

virus. To mitigate the effect of these measures, the government implemented a fiscal stimulus package. To help the economy of T&T fully recover from the pandemic lockdown measures, the government developed a strategic plan labeled “Roadmap for Trinidad and Tobago Post COVID-19 pandemic” [8]. Accompanying this plan was a TT\$500 million stimulus package to boost agriculture production [9].

Under the farming incentive program, the GORTT aims to promote the adoption of technology among farmers to enhance their productivity. As part of this initiative, farmers are eligible to receive a grant of up to TT\$100,000, which can be utilized for various purposes. These include facility upgrades, establishing new farms, ensuring access to financing through the Agricultural Development Bank (ADB), enhancing farming efficiency, and supporting fish processing and value-added activities [10].

Despite the existence of the agriculture stimulus program, a visual inspection of T&T’s food imports in Figure 1 reflects an uptrend. However, a view of a basic line graph is a superficial analysis. More rigor can be applied through regression analysis and an econometric forecast.

Notably, there is a dearth of research on T&T’s food imports. Recently, Charles [11] investigated the relationship between international food prices, freight rates, and T&T’s food inflation. However, the aforementioned study did not forecast T&T’s food imports. An econometric forecast of T&T is required as it will statistically confirm if T&T’s food imports are rising. Additionally, it will indicate what is the expected outcome for T&T’s food imports in a business-as-usual scenario.

The next sections facilitate the econometric analysis that forecasts T&T’s food imports. Section 3 will outline the methodology to forecast T&T’s food imports. Section 4 presents the results of the forecasting.

3. Methodology

3.1. Data

This study forecasts T&T’s food imports. It seeks to perform a univariate forecast. Therefore, data on only one variable are needed. The main variable of interest is T&T’s food imports.

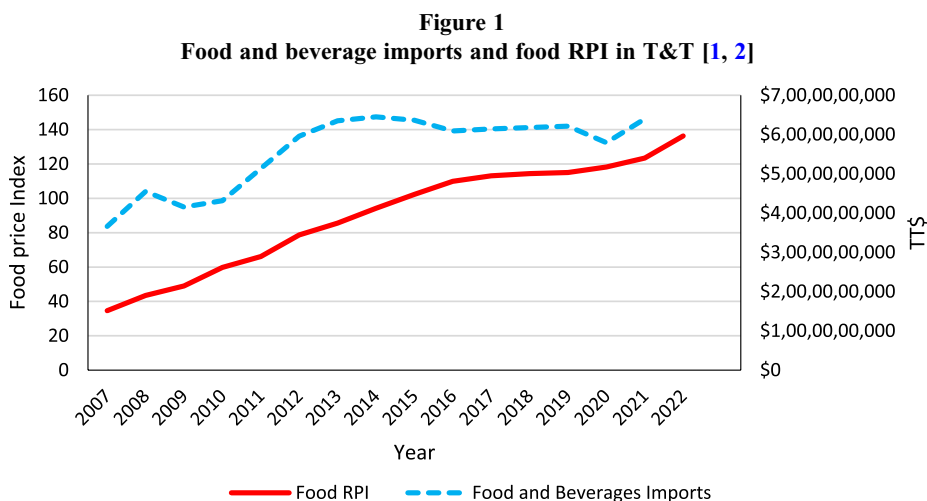

The data on T&T food imports are collected from T&T's Central Statistical Office database. The data include SITC 0 (food and live animals) and SITC 1 (beverages and tobacco).¹

The author initially sought a long period based on the available data to model T&T's food imports. However, preliminary structural break testing revealed several structural breaks. Notably, there was a structural break in 2018. This could have resulted from several macroeconomic factors that affected the international trade environment, such as the trade war between the United States and China, political uncertainty in Europe arising from Brexit², and a slowdown in the Chinese economy. Another structural break occurs in the year 2020, as the WHO declared COVID-19 as a pandemic, resulting in a major macroeconomic shock to the world, as many countries implemented lockdown measures. However, 2018 is used as the starting point to provide at least 5 years of data. The monthly frequency is used to increase the observations and regression modeling. Therefore, the data used for forecasting T&T's food imports cover January 2018 to November 2022 period.³

3.2. Methodology for forecasting T&T's food imports

Before regression is applied, a series of pretests are performed. First, the Jarque–Bera test is applied to test the data for normality. This step tests if the data are not normally distributed, then regression techniques based on the assumption of normality may be inaccurate. Second, the data are tested for stationarity. This is relevant since if the data are non-stationary, it should be differenced to become stationary before applying any regression. Third, the data are tested for linearity. This is relevant since the application of a linear model to non-linear data may result in model misspecification and large errors.

The regression method applied for forecasting T&T's food imports is a hybrid model comprised of several techniques, namely the empirical mode decomposition (EMD) and the artificial neural network (ANN). For cross-comparison, the results from the EMD-ANN model are compared to an autoregressive integrated moving average (ARIMA) model.

Particularly, several studies use hybrid forecast approaches involving a decomposition method and a neural network to perform univariate forecasts of economic variables [12–14]. These approaches are adopted as they do not have the linearity and normality assumption of the ARIMA model and should be statistically superior to the traditional ARIMA model's forecasts. Therefore, the use of the EMD-ANN model in this study is appropriate.

4. Results

4.1. Pretesting results

The pretesting results are displayed in Table 1.

The null hypothesis of the Jarque–Bera test is that the series is normally distributed. The alternative hypothesis is the series is not normally distributed. The probability of the Jarque–Bera test statistic was 0.0059. This was less than the 10%, 5%, and 1% level of significance, suggesting the rejection of the null hypothesis in favor of the alternative hypothesis. This suggests that T&T's food and beverage imports are not normally

Table 1
Descriptive statistics results

| FOOD | |
|--------------|-------------------------|
| Mean | 540,000,000 |
| Median | 523,000,000 |
| Maximum | 851,000,000 |
| Minimum | 353,000,000 |
| Std. Dev. | 102,000,000 |
| Skewness | 0.9360 |
| Kurtosis | 3.8155 |
| Jarque–Bera | 10.2507 |
| Probability | 0.0059 |
| Sum | 31,900,000,000 |
| Sum Sq. Dev. | 601,000,000,000,000,000 |
| Observations | 59 |

Table 2
Stationarity test results

| Test statistic | <i>P</i> |
|---------------------------------|----------|
| ADF level | 0.4870 |
| ADF 1 st difference | 0.0000 |
| PP level | 0.0079 |
| PP 1 st difference | 0.0000 |
| KPSS level | 0.579315 |
| KPSS 1 st difference | 0.378230 |
| Perron | 0.01 |
| KPSS critical values | |
| 1% level | 0.739000 |
| 5% level | 0.463000 |
| 10% level | 0.347000 |

distributed. Therefore, econometric models based on the assumption of normality are not appropriate for modeling.

Next, the stationary tests are applied. The results are in Table 2.

The null hypothesis of the Augmented Dickey–Fuller test (ADF) and the Phillips Perron (PP) tests is that the series has a unit root making it non-stationary. At level, the probability of the ADF statistic is greater than the 10%, 5%, and 1% levels of significance. This recommends the non-rejection of the null and suggests that T&T's food and beverage imports are non-stationary. This is inconsistent with the PP results that suggest T&T's food and beverage imports are stationary.

The null hypothesis of the Perron test is that the series is non-stationary and has a structural break. The probability of the Perron test statistic was less than the 10%, 5%, and 1% level of significance, leading to the rejection of the null. This suggested that T&T's food and beverage imports are stationary with a structural break.

The Kwiatkowski–Phillips–Schmidt–Shin (KPSS) is a right-tailed test (see Figure 2). The null hypothesis of the KPSS test is that the time series is stationary. At level, the KPSS test statistic of 0.5793 is greater than the 10% and 5% significance levels of 0.347000 and 0.463000, respectively; it suggests the rejection of the null at those levels, but not at the 1% level. This result suggests that T&T's food and beverage imports are non-stationary.

Next, the data are tested for structural breaks. The results are in Table 3.

First, the Bai–Perron tests of L+1 vs. L sequentially determined breaks tests for 1 break. Thus, the null hypothesis is that there are 0

¹These data are Standard International Trade Classification (SITC) Revision 4.

²The United Kingdom's exit from the European Union in March 2019.

³At the time of writing, November 2022 was the last month with available data.

Figure 2
KPSS critical region diagram [15]

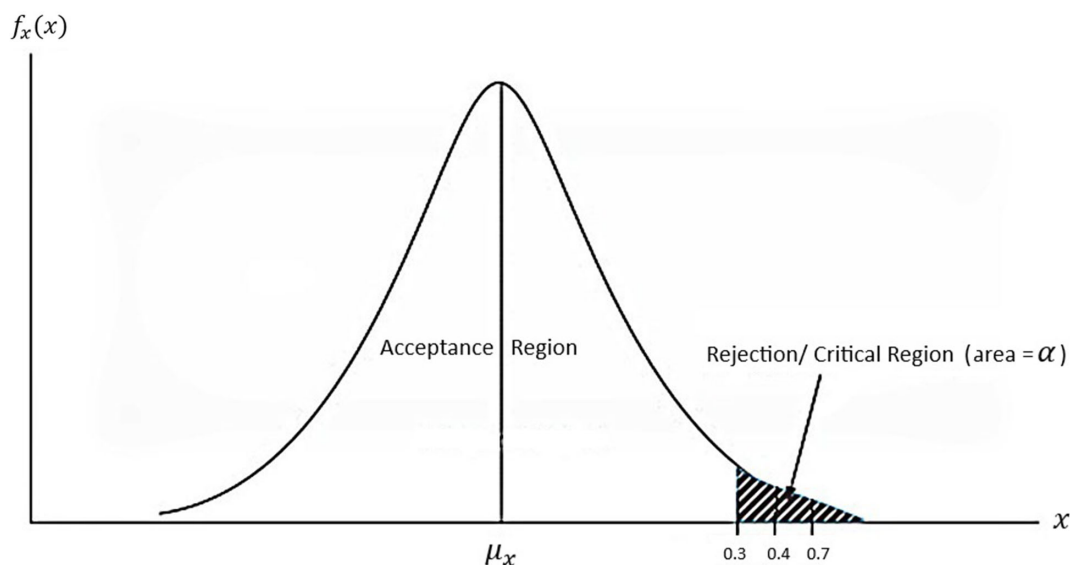

Table 3
Bai–Perron tests of L+1 vs. L sequentially determined breaks

| Sequential F-statistic determined breaks: | | | 1 |
|---|-------------|--------------------|------------------|
| Break test | F-statistic | Scaled F-statistic | Critical Value** |
| 0 vs. 1 * | 13.04308 | 26.08617 | 11.47 |
| 1 vs. 2 | 2.059669 | 4.119337 | 12.95 |

breaks, which is tested against the alternative hypothesis of 1 break. The test statistic of 26.086 is greater than the critical value of 11.47. This suggests the rejection of the null in favor of the alternative hypothesis. When the test is repeated against the alternative of 2 breaks, it leads to a non-rejection of the null. This suggests the presence of at least 1 structural break, indicating that the time series is non-linear. Therefore, a linear model is not appropriate for modeling.

The ADF and KPSS tests suggest that T&T’s food and beverage imports are non-stationary. But the PP and the Perron tests suggest that T&T’s food and beverage imports are stationary. Due to the finding of the absence of normality, the inconsistency in the stationary results, and the non-linear results, an ANN is applied for the regression since it can handle data with these statistical characteristics.

4.2. EMD NAR results

Next, the EMD is applied. The decompositions from the EMD are displayed in Figure 3. A total of 5 IMFs and 1 residual are produced.

As can be seen in Figure 3, IMFs 1 is exhibiting the most volatility. IMFs 1 to 4 seem to be exhibiting mean reversion. IMF 5 has 1 minima. The residual seems to be exhibiting an uptrend.

Next, the NAR ANN is used to forecast each IMF. The results are in Table 4.

The forecasts are performed 12 steps ahead, representing a 12-month forecast.

Notably, the application of the forecasting model on each IMF and the residual will provide diagnostic results for each signal.

Therefore, to assess the model performance, the average of the mean absolute percentage error (MAPE) is computed. The resulting average value of the MAPE from the ANN was 10.02%.

Additionally, a limitation of an ANN model is that it is a black box model. Furthermore, every time the ANN is run it produces slightly different results. Nevertheless, the ANN seems to produce the forecast results with the lowest MAPE when the ANN is trained for 3 epochs (see Figure 4).

4.3. Cross-comparison results

For cross-comparison, the ARIMA (1,1,1) model is used to forecast each IMF and the residual. The results are displayed in Table 5.

The MAPE from the forecast with the ARIMA (1,1,1) model is 13.67% (see Figure 5). This is slightly higher than the forecast result of the ANN model. Thus, the MAPE results suggest that the ARIMA (1,1,1) has a lower predictive accuracy than the NAR ANN model.

4.4. Summary of the results

The results of the EMD-NAR suggest that there will be an increase in T&T’s food imports, but it will fluctuate over time. Eventually, T&T’s food imports will rise to TT\$1,224,329,616.27 after 12 months.

The results of the EMD-ARIMA suggest that there will be a linear and continuous increase in T&T’s food imports. Eventually, T&T’s food imports will rise to TT\$1,382,972,644.76 after 12 months. However, this linear result is a consequence of the ARIMA being a linear model.

The EMD-ARIMA appears to provide a higher forecast for T&T’s food imports than the EMD-NAR. To visually see the results of both models, the forecast of the EMD-NAR-ANN is presented adjacent to the forecast of the EMD-ARIMA (1,1,1) model (see Figure 6).

As seen in Figure 6, the EMD-ARIMA (1,1,1) is linear and upward-sloping. This linear forecast is the consequence of the ARIMA being a linear model. The EMD-NAR-ANN exhibits

Figure 3
The IMFs of T&T’s food and beverages imports

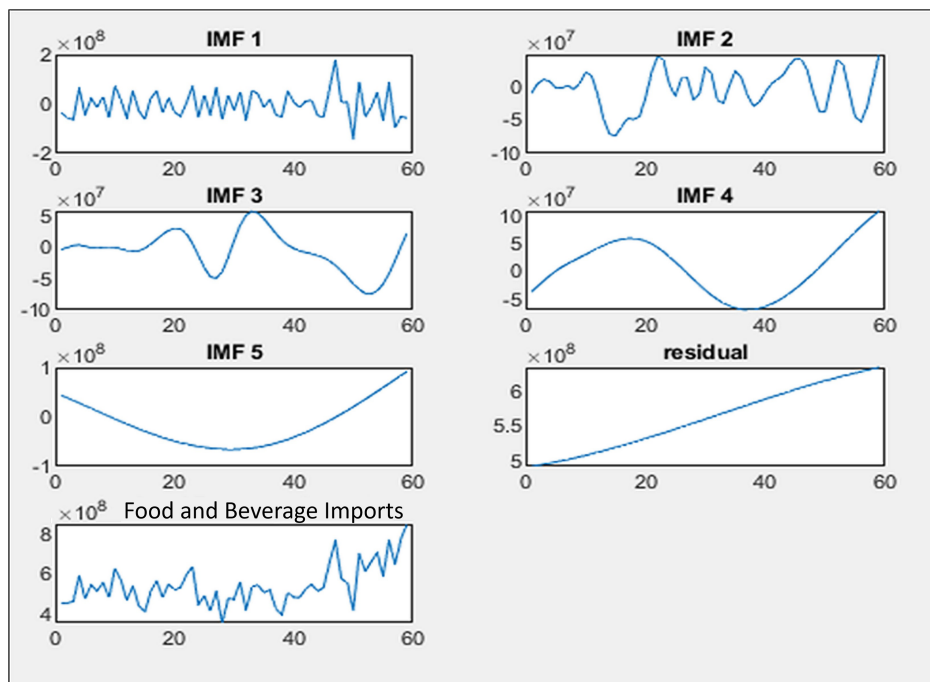

Table 4
Forecasted IMFs from the NAR

| | IMF 1 | IMF 2 | IMF 3 | IMF 4 | IMF 5 | Residual | Sum |
|----------------|----------------|----------------|----------------|-----------------|----------------|----------------|------------------|
| 1 step ahead | 294,490,704.48 | -6,317,039.99 | 69,263,510.22 | 40,148,240.58 | -15,584,235.32 | 637,541,312.08 | 1,019,542,492.06 |
| 2 steps ahead | 84,441,838.99 | -11,307,231.80 | 149,236,223.88 | 129,570,456.73 | 15,003,264.64 | 639,201,636.76 | 1,006,146,189.20 |
| 3 steps ahead | 431,062,981.15 | 16,359,170.09 | 157,372,251.63 | -145,841,721.84 | 22,758,344.89 | 640,769,329.84 | 1,122,480,355.76 |
| 4 steps ahead | 82,633,275.32 | 11,839,402.31 | 99,546,765.93 | 95,652,306.05 | 36,298,633.65 | 642,241,894.89 | 968,212,278.16 |
| 5 steps ahead | 414,494,903.08 | -9,128,765.46 | 100,223,867.43 | -176,142,467.01 | 35,578,861.19 | 643,617,432.27 | 1,008,643,831.49 |
| 6 steps ahead | 83,012,145.59 | -3,535,699.24 | 92,052,184.62 | 96,798,647.21 | -17,819,818.86 | 644,894,546.09 | 895,402,005.40 |
| 7 steps ahead | 416,778,421.44 | 16,210,646.96 | 94,452,138.13 | -176,427,091.89 | 106,645,831.86 | 646,072,631.71 | 1,103,732,578.20 |
| 8 steps ahead | 82,955,145.51 | 1,465,248.49 | 88,187,821.89 | 96,766,479.29 | 26,227,385.32 | 647,151,906.31 | 942,753,986.81 |
| 9 steps ahead | 416,476,856.82 | -7,947,684.75 | 91,993,202.05 | -176,428,018.51 | 14,987,201.00 | 648,133,574.41 | 987,215,131.03 |
| 10 steps ahead | 82,962,260.83 | 5,189,850.46 | 85,672,856.12 | 96,767,702.28 | 81,893,246.88 | 649,019,843.36 | 1,001,505,759.93 |
| 11 steps ahead | 416,517,320.70 | 10,628,622.31 | 90,999,161.35 | -176,428,069.77 | 7,581,608.01 | 649,813,956.67 | 999,112,599.27 |
| 12 steps ahead | 82,961,284.48 | -4,433,076.70 | 183,712,642.94 | 296,767,658.79 | 14,800,988.59 | 650,520,118.17 | 1,224,329,616.27 |

fluctuation as the model is non-linear and better matches the data. However, both forecasts reveal that T&T’s food and beverage imports are likely to increase. Therefore, in a business-as-usual situation, T&T’s food import bill is likely to become higher resulting in greater food insecurity. This finding justifies new or enhanced policy action to address T&T’s food import problem.

The next section discusses the technical requirements for the aquaponics industry, as it can help T&T address its food security concerns while helping the country transition to a low-carbon economy.

5. Policy Response

Given that the previous section statistically confirmed that T&T’s food imports are increasing, it suggests that the existing agriculture policies to stimulate primary agriculture production in the country are not working. Subsequently, this study proposes

the development of the aquaponics industry locally as a means to increase primary agriculture output and reduce food imports.

5.1. The technical requirements for aquaponics systems

Aquaponics is a sustainable farming method that combines aquaculture (fish farming) and hydroponics (soilless plant cultivation), creating a symbiotic ecosystem where fish waste provides nutrients for plants, and the plants help purify the water for the fish [16].

Aquaponics have been historically used by indigenous societies to provide food for their populations. Early versions have been applied in China, Mexico (Chinampas), Malaysia, and Vietnam [17–19].⁴

⁴Carrasco, G. (2020). A practical introduction to aquaponics. EC 400: Independent study in aquaponics. Retrieved from: https://blogs.goucher.edu/symposium/files/2020/05/Aquaponics_-_Gabriella-Carrasco.pdf

Figure 4
Validation performance

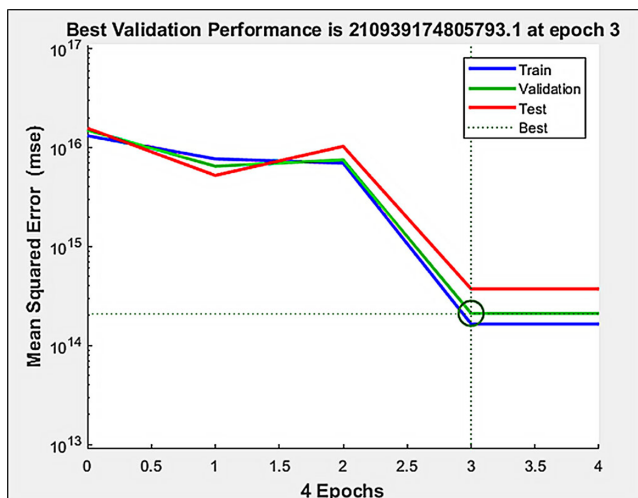

Modern aquaponics emerged in the 1980s and 1970s. Early pioneers include Dr. K. Sneed, Dr. William Lewis, Dr. Ronald Zweig, Dr. Nair, and Dr. James Rakocy [20–23].

Based on the progress made, the present standard for commercial aquaponics is centered around the University of the Virgin Islands (UVI) [24]. The UVI system was comprised of four fish tanks, six plant troughs, a clarifier tank, screen filter tanks, degassing tanks, a sump tank, a base addition tank, a water pump, two air blowers, and over 200 air stones [25] (see Figure 7).

The following subsections review the key factors of each component.

5.2. Fish tanks

Fish tanks are an integral component of aquaponics systems as they provide a habitat for fish. Some of the most commonly used freshwater fish in aquaponics systems include tilapia, catfish, largemouth bass, crappies, rainbow trout, pacu, common carp, koi, and goldfish. The freshwater fish that are appropriate for aquaculture and aquaponics systems are those that can tolerate high stocking density conditions [26–28]. Of these, Tilapia emerges as a

Table 5
Forecasted IMFs from the ARIMA (1,1,1)

| | IMF 1 | IMF 2 | IMF 3 | IMF 4 | IMF 5 | Residual | Sum |
|----------------|----------------|----------------|----------------|----------------|----------------|----------------|------------------|
| 1 step ahead | -7,243,093.41 | 71,976,733.80 | 43,292,340.56 | 117,259,240.57 | 100,335,063.98 | 637,605,206.28 | 963,225,491.78 |
| 2 steps ahead | -22,073,239.58 | 82,666,117.40 | 62,913,158.87 | 125,876,636.74 | 108,790,445.41 | 639,454,122.77 | 997,627,241.62 |
| 3 steps ahead | -18,142,181.36 | 88,020,730.04 | 81,470,054.60 | 134,702,678.69 | 117,411,931.88 | 641,336,545.86 | 1,044,799,759.71 |
| 4 steps ahead | -19,743,494.96 | 91,297,195.23 | 99,042,383.49 | 143,736,519.22 | 126,199,523.34 | 643,251,347.02 | 1,083,783,473.34 |
| 5 steps ahead | -19,713,402.75 | 93,764,122.98 | 115,703,582.33 | 152,977,314.56 | 135,153,219.78 | 645,197,435.72 | 1,123,082,272.62 |
| 6 steps ahead | -20,164,385.39 | 95,915,697.33 | 131,521,610.41 | 162,424,224.37 | 144,273,021.15 | 647,173,758.17 | 1,161,143,926.04 |
| 7 steps ahead | -20,473,506.93 | 97,944,426.50 | 146,559,358.06 | 172,076,411.72 | 153,558,927.42 | 649,179,296.07 | 1,198,844,912.84 |
| 8 steps ahead | -20,824,460.99 | 99,925,301.63 | 160,875,024.77 | 181,933,043.07 | 163,010,938.55 | 651,213,065.42 | 1,236,132,912.47 |
| 9 steps ahead | -21,163,079.32 | 101,887,535.33 | 174,522,469.05 | 191,993,288.29 | 172,629,054.53 | 653,274,115.36 | 1,273,143,383.23 |
| 10 steps ahead | -21,505,335.25 | 103,842,507.30 | 187,551,532.20 | 202,256,320.59 | 182,413,275.30 | 655,361,527.04 | 1,309,919,827.18 |
| 11 steps ahead | -21,846,518.52 | 105,794,650.48 | 200,008,338.00 | 212,721,316.55 | 192,363,600.84 | 657,474,412.59 | 1,346,515,799.94 |
| 12 steps ahead | -22,188,018.10 | 107,745,691.72 | 211,935,569.90 | 223,387,456.10 | 202,480,031.12 | 659,611,914.02 | 1,382,972,644.76 |

Figure 5
MSE of the ARIMA (1,1,1)

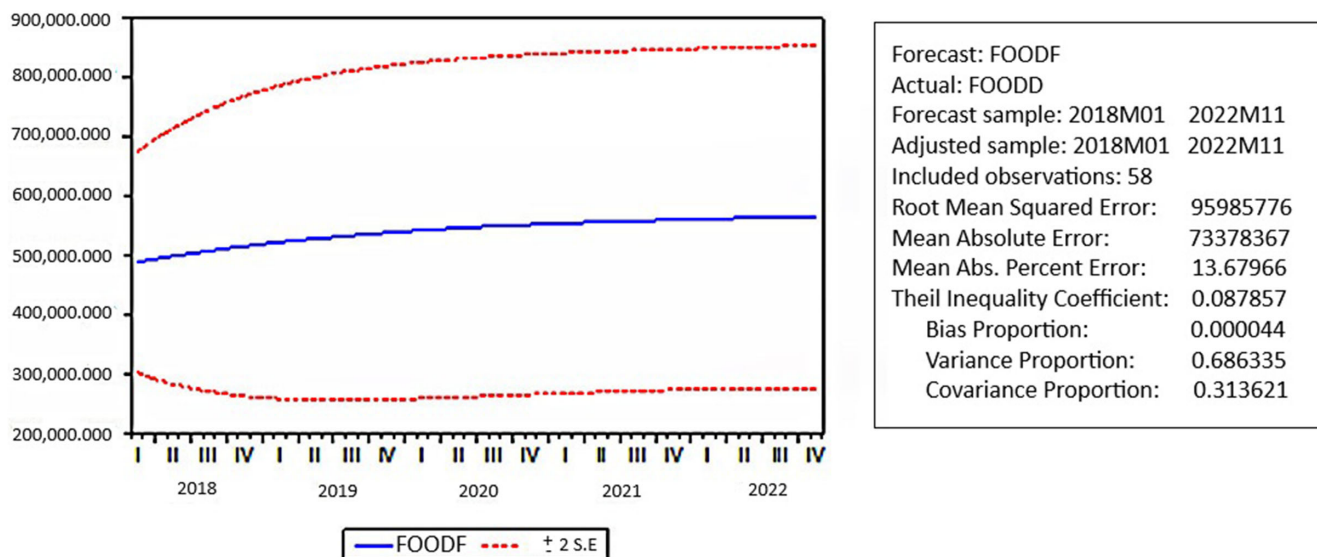

Figure 6
T&T's food and beverages imports forecasts with the EMD-NAR-ANN vs the EMD-ARIMA (1,1,1)

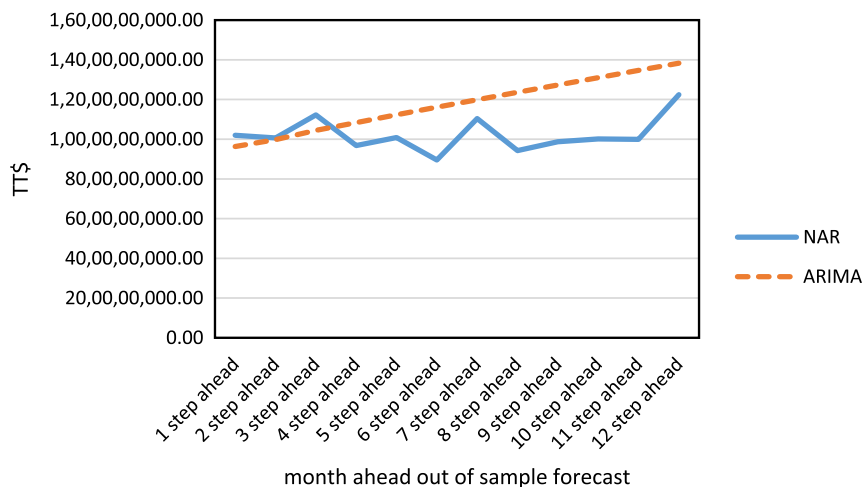
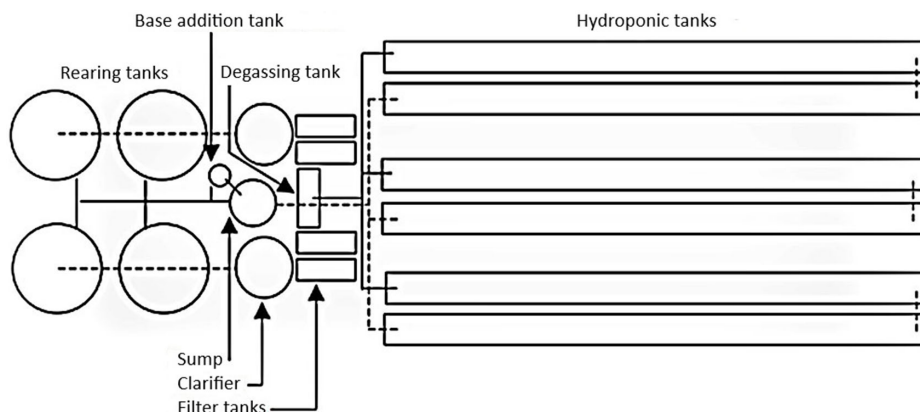

Figure 7
UVI RAS [25]



common fish, especially for commercial aquaponics systems as it can tolerate high stocking density, and it can thrive in tropical and temperate climates [28]. For this study, only tilapia is considered.

Tilapia can be sold at markets when they are 400 g in size. However, they can grow up to 2 kg (2000 g) [29]. The stocking density should be 1 fish per ft² [28]. If 1 ft² = 28.3168 l, then 1000 l would produce a stocking density of 1000/28.3168 = 35.314 adult fish/1000 l. Based on a weight of 2 kg per adult, it would result in a carrying capacity of 70.628 kg/1000 l.⁵

This information would be useful in determining the total number of fish that could be accommodated in each size tank. For example, if a fish tank is 4000 l, then the total number of fish should be 35 × 4 = 140. This will result in a total fish weight of 280 kg.⁶

Remarkably, if in practice the average individual weight of the fish before harvest is lower than 2 kg, then this weight should be used for the estimation of the total number of fish per tank. For example, assume the fish were harvested at 400 g rather than 2 kg. Then based on a carrying capacity⁷ of 70 kg/1000 l, then the stocking density before harvest should be 70/0.4 = 175 fish/1000 l. Then the 4000 l tank could accommodate 175 × 4 = 700 fish. The total fish weight would still be 280 kg, since 700 × 0.4 kg = 280 kg.

Tilapia could be fed 1–3 times per day. Fry should be given a feed that comprises 40% protein. They can be fed as high as 20% of their body weight per day. For example, if the fry on average weighs 150 g, and there are 700 fry in a tank, then the total weight of all the fry is 150 g × 700 = 105,000 g (105 kg). Therefore, the total volume of feed per day that should be administered to the fish tank is 20% × 105 kg = 21,000 g (21 kg).

⁵35.314 fish * 2 kg = 70.628 kg of fish.

⁶140 fish * 2 kg = 280 kg of fish.

⁷The carrying capacity refers to the amount of fish in weight per volume of water. For example, 70 kg/1000 l is the carrying capacity (Turnbull, 2010). Fish stocking density refers to the amount of fish in numbers per volume of water. For example, 175 fish/1,000 liter is the fish stocking density.

5.3. Solid waste filtration

Solid waste removal is a fundamental step in every recirculating aquaculture system (RAS) to maintain good water quality for fish health and growth.

The initial goal of a solid waste filter is to reduce the retention time of solids in the system as much as possible. The sooner solid waste is removed from the system, the lower the likelihood for the solid waste to break down into smaller particles where they become more difficult to treat [30].

There are several methods for solid waste filtration in RAS. These methods include sedimentation, radial flow separators, screening, drum filters, sand filters, bead filters, and foam fractionators [31].

5.4. Biological filtration

Biological filtration involves the use of bacteria to break down toxic ammonia produced by the fish waste and uneaten feed, into less harmful nitrate that can be absorbed by the plants as a nutrient [31].

The primary role of biological filters is to provide a large surface area for the colonization of bacteria. This surface area allows the ammonia in the water to come into contact with the bacteria, facilitating the conversion of ammonia to nitrite and further to nitrate [31].

The most commonly used biological filters are trickle filters, fluidized bed filters, sand filters, bead filters, and moving bed bioreactors. Since some of the same media that can be used for solid waste filtration can also be used for biological filtration, many manufacturers create filters to perform the function of both solid waste filtration and biological filtration [31].

5.5. Hydroponic units

There are different types of hydroponic units in aquaponics systems. The main designs include the nutrient film technique (NFT), Media bed, and deep water culture (DWC).

NFT employs horizontal pipes with holes, where net cups hold plants nourished by a thin film of water flowing through the pipes. It is ideal for shallow-rooted crops like herbs and leafy vegetables [32].

Media bed aquaponics uses a grow bed with growing media such as pebbles, and other small inert (pH neutral) substances for the hydroponics section. It can support a wide range of vegetation including herbs, green leafy vegetables, root crops, and fruiting plants. Additionally, media beds can act as a form of solid waste filtration and biological filtration [31, 32].

DWC relies on rafts floating on the nutrient-rich water for the hydroponics section. The plants are placed in net cups and their roots absorb nutrients from the culture water.

5.6. Sump

The sump is an essential component of a RAS. It is a tank or reservoir located below the fish tanks, which collects and stores water from the system. The sump serves several important functions. They include water storage, water filtration, water treatment, temperature control, and oxygenation [32].

5.7. Discussion

Aquaponics farms entail higher initial capital costs due to the need for additional components not found in traditional soil-based farming systems. Consider multiple scenarios of costs.

5.7.1. Economic policy framework required to support the aquaponics industry in T&T

Scenario 1 – Aquaponics System but no Cost for Greenhouse

Assume that an aquaponics system has 4 fish tanks. Each tank has a capacity of 1000 l. Therefore, the 4 fish tanks collectively have a capacity of 4000 l. The total number of fish in the tanks could be 140. The total fish weight at full size is 280 kg. The fish feed at 20% of body weight per day, so the total fish feed is 56 kg. Assuming a conservative feed-to-waste ratio of 1:1, the fish will produce 56 kg of waste per day. Assuming that the aquaponics system has an area of 100 square feet allocated for growing lettuce, it can produce approximately 100 pounds of lettuce per month. While the aquaponics system can have a greenhouse, for this scenario the greenhouse costs are ignored. The fixed cost of such a system is represented in Table 6.

The operational cost of the system will include the cost of the fish feed, which is approximately TT\$200 per 5 mm bag per month.

Although the price of agricultural produce varies, on average 1 head of lettuce is priced at TT\$6 in T&T. Since 1 head of lettuce is approximately 1 pound, then 100 pounds of lettuce can generate TT \$6 × 100 = TT\$600 per month.

Additionally, the price of fish can also vary. However, on average the price of tilapia in T&T is approximately TT\$42 per kg. Tilapia grow from fingerlings (babies) to a size of around 400 g under optimal conditions in 6 months. Therefore, the revenue from tilapia can be 280 kg × TT\$42 = TT\$11,760 per 6 months.

Collectively, the lettuce and fish can generate (TT\$600 × 12) + (TT\$11,760 × 2) = TT\$30,720 in revenue per annum. Therefore, the payback period for this investment would be 1.55 years. The project will also be profitable resulting in a net present value (NPV) of TT \$12,642.86 after 2 years.

Scenario 2 – Aquaponics System Including the Cost of Greenhouse

Table 6
Net present value of an aquaponics system (TTD)

| | Year 1 | Year 2 |
|---|-------------|-------------|
| Item | Cost | |
| 4 Fish tanks (each is 1000 gallons) | \$8000 | |
| AST Bubble Bead Filter XS8000 Up to 8000 Gallons ⁸ | \$22,393 | |
| DWC hydroponic unit | \$4000 | |
| Sump | \$2000 | |
| PVC fittings | \$1000 | |
| Glue | \$200 | |
| Power saw | \$3000 | |
| Water pump | \$1000 | |
| Air pump | \$1000 | |
| Labor to set up the aquaponics system | \$200 | |
| Fish feed | \$2400 | \$2400 |
| Total cost | \$45,193 | \$2400 |
| Revenue | | |
| Tilapia fish | \$23,520 | \$23,520 |
| Lettuce | \$7200 | \$7,200 |
| | \$30,720 | \$30,720 |
| Net cash flow | −\$14,473 | \$28,320 |
| PVIF ⁹ | 0.9709 | 0.9426 |
| Discounted cash flow | − | \$26,694.32 |
| | \$14,051.46 | |
| NPV | | \$12,642.86 |
| Payback | | 1.55 |

Table 7
Net present value of an aquaponics system with greenhouse (TTD)

| | Year 1 | Year 2 | Year 3 | Year 4 | Year 5 | Year 6 |
|-------------------------------------|---------------|-------------|-------------|-------------|-------------|-------------|
| Item | Cost | | | | | |
| 4 Fish tanks (each is 1000 gallons) | \$8000 | | | | | |
| AST Bubble Bead Filter XS8000 | \$22,393 | | | | | |
| Up to 8000 Gallons | | | | | | |
| DWC hydroponic unit | \$4000 | | | | | |
| Sump | \$2000 | | | | | |
| PVC fittings | \$1000 | | | | | |
| Glue | \$200 | | | | | |
| Power saw | \$3000 | | | | | |
| Water pump | \$1000 | | | | | |
| Air pump | \$1000 | | | | | |
| Labor to set up the aquaponics | \$200 | | | | | |
| Greenhouse | \$100,000 | | | | | |
| Fish feed | \$2400 | \$2400 | \$2401 | \$2402 | \$2403 | \$2404 |
| Total cost | \$145,193 | \$2400 | \$2401 | \$2402 | \$2403 | \$2404 |
| Revenue | | | | | | |
| Tilapia fish | \$23,520 | \$23,520 | \$23,520 | \$23,520 | \$23,520 | \$23,520 |
| Lettuce | \$7200 | \$7200 | \$7200 | \$7200 | \$7200 | \$7200 |
| | \$30,720 | \$30,720 | \$30,720 | \$30,720 | \$30,720 | \$30,720 |
| Net cash flow | -\$114,473 | \$28,320 | \$28,319 | \$28,318 | \$28,317 | \$28,316 |
| PVIF | 0.9709 | 0.9426 | 0.9151 | 0.8885 | 0.8626 | 0.8375 |
| Discounted cash flow | -\$111,138.83 | \$26,694.32 | \$25,915.90 | \$25,160.18 | \$24,426.49 | \$23,714.20 |
| NPV | | | | | | \$14,772.25 |
| Payback | | | | | | 5.12 |

Consider a second scenario of an aquaponics system where the farmer incurs a cost for the greenhouse. The results are displayed in Table 7.

Scenario 2 differs from scenario 1 only by the cost of the greenhouse. The cost of the greenhouse is estimated to be TT \$100,000. However, this cost could be higher depending on the style and quality of the greenhouse.

When the greenhouse cost is included, the payback period to recover the initial investment is 5.12 years. Additionally, the NPV after 6 years is TT\$14,772.25. Therefore, even if a farmer incurs the cost of a greenhouse, an aquaponics system can still be profitable. However, it will take 6 years for the aquaponics farmer to realize these profits.

Scenario 3 – Traditional Outdoor Soil-Based Farming System

In comparison, in a traditional outdoor soil-based farming system, a farmer can try to cultivate 100 pounds of lettuce per month. However, several factors might reduce the farmer’s produce including adverse weather conditions, insects, crop disease, and larceny. These factors may prevent the farmer from maintaining a consistent supply of 100 pounds of lettuce per month. In contrast, these factors would not be present in an aquaponics system as the greenhouse.

If the outdoor soil farmer is fortunate, they may be able to produce 100 pounds of lettuce per month. This can generate TT \$7200 in revenue per annum. If the farmer uses synthetic fertilizer to maintain their yields, their operational cost could be TT\$200 per annum. This can produce an NPV of \$7000 per annum. Additionally, the payback period is less than 1 indicating that the project can be profitable within the first year (see Table 8).

Due to the difference in cost, and the fast payback period, many farmers T&T may opt for the traditional outdoor-based system. However, it can be noted that after the initial cost of investment is recovered, the aquaponics system will generate a higher discount cash flow per annum than the traditional outdoor soil-based farming system.

Table 8
Net present value of a traditional outdoor soil-based farming system (TTD)

| | Year 1 |
|-----------------|--------|
| Item | Cost |
| Fertilizer cost | \$200 |
| Total cost | \$200 |
| Revenue | |
| Lettuce | \$7200 |
| NPV | \$7000 |
| Payback | 0.02 |

The next subsection will consider the enabling environment provided by the government for the agriculture sector.

5.7.2. Government enabling environment

The GORTT currently has several incentives for the agriculture sector. They include the following.

1) VAT Exemption on the importation and acquisition of equipment for the Commercial Fishing Sector

A person may request a VAT exemption from the Minister of Agriculture if they are importing or purchasing any fishing boats, marine engines, fishing nets, lines, or other capital equipment purely to operate a commercial fishing operation [33].

2) Vat Exemption on New and Used Selected Vehicles

Registered farmers can access VAT exemptions for Light Goods vehicles under 2950 MGW, and trucks ranging from 2950 to 5000 kg MGW. This VAT exemption is up to TT\$5000 [33].

3) *Duty-Free Concessions on Agricultural Equipment and Machinery*

Members of the public who are engaged in lawful agricultural operations or who are supporting such activities may access duty-free concessions. Eligible individuals and organizations will be exempt from import/customs duties on imported machinery and equipment used for agricultural activities approved by the Ministry of Agriculture [33].

4) *Agricultural Finance Support Program*

This program helps registered agriculture stakeholders (such as farmers, fishermen, and woodcutters) acquire new tools and technology. Successful candidates may be eligible for a grant of up to TT\$100,000 [33].

5) *The Agricultural Incentive Program*

The Agricultural Incentive Program provides a set of discounts and exemptions on goods and services to agriculture stakeholders registered with the Ministry of Agriculture. A rebate on a percentage of the overall cost is granted to agriculture stakeholders.

6) *Grant Fund Facility*

The program finances small and medium enterprises operating in many industries, including agriculture and agro-processing. The monies can be used for the acquisition of new capital, with a cap of TT\$250,000 [33].

7) *Research and Development Facility*

This program provides funding for manufacturing companies to engage in research to encourage product development. Stakeholders in the primary agriculture and agro-processing sectors can also apply for this funding.

8) *ADB Secure Loan*

The ADB provides a government-backed loan specifically designed for agriculture entrepreneurs, featuring a low effective interest rate of 3% [33].

9) *Vehicle Package Loan*

The ADB offers a government-backed loan for agriculture stakeholders to acquire either a new or used vehicle, with a low effective interest rate of 5%. To qualify for this loan, entrepreneurs need to meet certain lending criteria, including being registered as a farmer or fisherman with the Ministry of Agriculture and a citizen of T&T who is at least 18 years old [33].

10) *Revolving Loan Account*

Through the ADB, an overdraft facility is provided to agriculture stakeholders registered with the Ministry of Agriculture. This funding can be used to cover working capital for their operations. The minimum lending limit of this facility is TT\$10,000.00, with an effective interest rate of 5% [33].

11) *TT\$500 Million Agriculture Stimulus Package*

Apart from the existing agriculture incentives, the GORTT introduced the TT\$500 million stimulus package for the agriculture sector, as part of its roadmap to recovery from COVID-19.

5.7.3. *Modifying the enabling environment to encourage aquaponics*

The problem in T&T's agriculture industry is not the unavailability of government incentives. The review of the enabling environment reveals several incentives that can be used for the aquaponics industry.

However, the obstacle to the development of an aquaponics industry in T&T appears to be the economics. Establishing a professional aquaponics farm, including a greenhouse, can take up to 6 years to recover the initial investment before earning a profit. This economic aspect discourages farmers, who may find traditional soil-based outdoor farming more financially viable, despite aquaponics' long-term benefits.

Only slight modification to the existing enabling environment is required to encourage aquaponics.

There is a need to properly train farmers in agriculture economics. The farmers should be trained in microeconomic theory about fixed costs, variable costs, profit-maximizing output, market equilibrium, and how to conduct project evaluation.

Government assistance is crucial to support aquaponics farming in greenhouses and alleviate the upfront capital costs for farmers. To create an enabling environment, several measures can be implemented. Firstly, students participating in the Youth Agricultural Homestead Program should receive comprehensive training in aquaponics, covering small-scale, medium-scale, and large-scale systems. They should gain practical knowledge about key concepts like plant and fish nutrition, fish stocking density, monitoring pH, temperature, and nutrient levels, separating fingerlings from adults, and packaging and storing produce for the market.

Secondly, students who complete the first year of the program should be eligible for an aquaponics grant, which can be integrated into the existing grants offered under the Youth Agricultural Homestead Program. This incentivizes and supports their pursuit of aquaponics farming.

Thirdly, registered farmers should have access to a separate grant of approximately TT\$100,000 specifically dedicated to establishing greenhouses. This grant is distinct from the TT \$100,000 grant available under the Agricultural Finance Support Program. Constructing high-quality greenhouses ensures a controlled environment that mitigates threats from pests, diseases, and adverse weather conditions while safeguarding produce and minimizing the risk of theft.

Fourthly, successful graduates of the Youth Agricultural Homestead Program should receive assistance from the National Agricultural Marketing and Development Corporation (NAMDEVCO) in securing contracts for their produce. Acting as an intermediary, NAMDEVCO can facilitate contracts with supermarket chains and agro-processors across T&T.

Furthermore, there is a pressing need to reintroduce fish processing services for small-scale aquaponics farmers. Previously, the state-owned Sugar Cane Feed Centre in Longdenville, Chaguanas provided such services but faced operational challenges and was subsequently closed down. Re-establishing fish processing facilities is essential as small-scale farmers may lack the capacity to process and package fish independently. These services would include packaging machines, vacuum sealers, label printers, and freezers. They would greatly assist aquaponics farmers in supplying fish to supermarkets and potentially engaging in fish exports.

Lastly, the GORTT should sustain its "buy local" campaign, which forms part of the TT\$500 Million Agriculture Stimulus Package. This campaign encourages the support and consumption

of locally produced agricultural products, including those from aquaponics farms.

The next section concludes this study.

6. Conclusion

This study had two objectives. First, this study sought to analyze and forecast T&T's food imports. The results from the forecasting analysis reveal that T&T's food imports are rising. More specifically, a forecast of T&T's food imports based on an EMD-ANN model suggests that over the next 12 months, T&T's food imports will increase. By month 12, T&T's food imports will rise to TT\$1,224,329,616.27. For cross-comparison, an EMD-ARIMA was used to forecast T&T's food imports. The EMD-ARIMA provides a linear forecast which also suggests that T&T's food imports will increase. Therefore, under a business-as-usual situation, T&T's food import bill is likely to become higher. This finding is serious as it means if nothing new is done, T&T would become more vulnerable to importing food inflation and face food insecurity.

The second objective of this study was to develop a policy response to address T&T's food imports. As the aquaponics industry was considered as a solution, this study sought to examine the technical and economic policy requirements for an aquaponics industry in T&T.

This study recommends the adoption of the UVI aquaponics systems, for commercial-scale aquaponics in T&T. The system consists of essential components such as fish tanks, solid waste filtration, biological filtration, hydroponic units and grow beds, and a sump.

Concerning the economic policy requirements, this study found that the problem in T&T's agriculture industry is not the unavailability of government incentives. While various incentives exist to support the aquaponics industry, the upfront capital costs for establishing a professional aquaponics farm, including the cost of greenhouses, can take up to 5.12 years to recover before farmers can start earning profits. This economic aspect discourages farmers, especially when they can opt for traditional soil-based outdoor farming without incurring such costs. Despite the long-term benefits of aquaponics outweighing the costs, farmers may not fully comprehend this.

To encourage the adoption of aquaponics, certain modifications to the existing enabling environment are necessary. Farmers should receive proper training in agriculture economics, covering topics such as microeconomic theory, fixed costs, variable costs, profit-maximizing output, market equilibrium, and project evaluation. This knowledge will equip them with a better understanding of the economic dynamics involved in aquaponics farming.

Government assistance plays a crucial role in supporting aquaponics farming in greenhouses and alleviating the upfront capital costs for farmers. Several measures can be implemented to create an enabling environment. Firstly, comprehensive training in aquaponics should be provided to students participating in the Youth Agricultural Homestead Program, encompassing different scales of systems.

Secondly, students who successfully complete the first year of the program should be eligible for an aquaponics grant, which can be integrated into the existing grants offered under the Youth Agricultural Homestead Program. This additional incentive encourages and supports their venture into aquaponics farming.

Thirdly, registered farmers should have access to a separate grant of approximately TT\$100,000 specifically designated for establishing greenhouses. This grant should be distinct from the TT\$100,000 grant available under the Agricultural Finance Support Program. By constructing high-quality greenhouses, farmers can create controlled

environments that mitigate risks posed by pests, diseases, and adverse weather conditions, ensuring the safety and quality of their produce while minimizing the risk of theft.

Fourthly, successful graduates of the Youth Agricultural Homestead Program should receive assistance from NAMDEVCO in securing contracts for their produce.

Fifthly, there is an urgent need to reintroduce fish processing services for small-scale aquaponics farmers. The reintroduction of fish processing facilities, including packaging machines, vacuum sealers, label printers, and freezers, will support aquaponics farmers in producing fish for local supermarkets and exploring export opportunities.

This study contributes to the literature, as no study examines the economic viability of the aquaponics industry in T&T, including the estimation of the NPV and the payback period. Estimating the NPV of aquaponics ventures is a fundamental economic evaluation that considers the costs and benefits associated with the investment. The payback period is a critical metric for farmers and investors, as it provides insights into the timeframe required to achieve profitability and recoup the upfront capital costs. By conducting an analysis of the economic aspects, this study fills a crucial knowledge gap and provides valuable insights for policymakers, researchers, and practitioners interested in promoting and supporting the aquaponics industry in T&T. Moreover, the results from the NPV analysis highlight the need for government financial support to remove the cost burden for potential aquaponics farmers.

The development of the aquaponics industry helps T&T transition to a low-carbon economy. This can help T&T with its climate change goals. While T&T did not highlight aquaponics as a sector for action in its Nationally Determined Contributions submitted to the United Nations Framework Convention on Climate Change for the Paris Agreement, it can help in the climate mitigation fight as it encourages agriculture production without ammonia-based fertilizers.

As future research, there is scope to explore how the development of the aquaponics industry can address the twin challenges of boosting agriculture output and reducing greenhouse gas emissions that would be produced from the petrochemical sector if ammonia-based fertilizer was produced for local agriculture production. This research can help encourage food security while helping a country transition to a low-carbon economy.

Ethical Statement

This study does not contain any studies with human or animal subjects performed by any of the authors.

Conflicts of Interest

The author declares that he has no conflicts of interest to this work.

Data Availability Statement

Data available on request from the corresponding author upon reasonable request.

Author Contribution Statement

Don Charles: Conceptualization, Methodology, Software, Validation, Formal analysis, Investigation, resources, data curation, Writing – original draft, Writing – review & editing, Visualization, Supervision, Project administration.

References

- [1] Central Statistical Office. (2023). *International trade*. Retrieved from: <http://csottwebtext.gov.tt:8001/eurotrace/submitlayoutselect.do>
- [2] Central Bank of Trinidad and Tobago. (2023). *Data centre*. Retrieved from: <https://www.central-bank.org.tt/statistics/data-centre/>
- [3] Government of the Republic of Trinidad and Tobago, Ministry of Youth Development and National Service. (2022). *Deadline for Youth Agricultural Homestead Programme (YAFP) applications extended to March 24*. Retrieved from: <https://www.mydns.gov.tt/media/releases/deadline-for-youth-agricultural-homestead-programme-yahp-applications-extended-to-march-24/>
- [4] United Nations High Commissioner for Refugees. (2022). *Trinidad and Tobago country overview*. Retrieved from: <https://help.unhcr.org/trinidadandtobago/about-trinidad-and-tobago/country-information/>
- [5] Seepersad, J., & Ganpat, W. (2008). *Trinidad & Tobago*. Retrieved from: https://uwispace.sta.uwi.edu/dspace/bitstream/handle/2139/47304/Ganpat_W_UWISTA_2008_03.pdf?sequence=1&isAllowed=y
- [6] Allard, L. A. (2012). *The contribution of small farms and commercial large farms to the food security of Trinidad and Tobago*. Master of Arts, DePaul University.
- [7] Premdas, R., & Ragoonath, D. (2020). *Oil and gas, from boom to bust and back: The Trinidad experience with the resource curse*. Working Paper Series, WP 2020 No. 1, Department of Government, Sociology, Social Work & Psychology, the University of the West Indies, Cave Hill Campus, Barbados. [https://www.cavehill.uwi.edu/fss/gssw/resources/workingpapers/draft_oil-and-gas,-from-boom-to-bust-and-back-\(1\).aspx](https://www.cavehill.uwi.edu/fss/gssw/resources/workingpapers/draft_oil-and-gas,-from-boom-to-bust-and-back-(1).aspx)
- [8] Government of Trinidad and Tobago. (2020). *Roadmap for Trinidad and Tobago Post COVID-19 pandemic*. Retrieved from: https://www.planning.gov.tt/sites/default/files/Report%20of%20the%20Roadmap%20to%20Recovery%20Committee_1st.pdf
- [9] Government of the Republic of Trinidad and Tobago, Ministry of Agriculture, Land and Fisheries. (2022). *Concept and information note – TT agri-investment forum and expo ii: Transforming agriculture through innovation and investment*. Retrieved from: <https://agriculture.gov.tt/wp-content/uploads/2022/08/CONCEPT-NOTE-FOR-AGRI-FORUM-EXPO-II.pdf>
- [10] Government of the Republic of Trinidad and Tobago, Ministry of Agriculture, Land and Fisheries. (2020). *Governance framework for the agricultural finance support programme (Agro-incentive)*. Retrieved from: <https://agriculture.gov.tt/wp-content/uploads/2020/06/Agricultural-Finance-Support-Programme-Agro-Incentive-Governance-Framework-and-Form-Revised-Document.pdf>
- [11] Charles, D. (2023). The lead-lag relationship between international food prices, freight rates, and Trinidad and Tobago's food inflation: A support vector regression analysis. *Green and Low-Carbon Economy*, 1(2), 94–103. <https://doi.org/10.47852/bonviewGLCE3202797>
- [12] Cortazar, G., Ortega, H., & Valencia, C. (2021). How good are analyst forecasts of oil prices?. *Energy Economics*, 102, 105500. <https://doi.org/10.1016/j.eneco.2021.105500>
- [13] Davidescu, A. A., Apostu, S. A., & Paul, A. (2021). Comparative analysis of different univariate forecasting methods in modelling and predicting the Romanian unemployment rate for the period 2021–2022. *Entropy*, 23(3), 325. <https://doi.org/10.3390/e23030325>
- [14] Safari, A., & Davallou, M. (2018). Oil price forecasting using a hybrid model. *Energy*, 148, 49–58. <https://doi.org/10.1016/j.energy.2018.01.007>
- [15] Ibe, O. (2014). *Fundamentals of applied probability and random processes*. United States: Elsevier Academic Press.
- [16] Goodman, E. R. (2011). *Aquaponics: Community and economic development*. Master's Thesis, The Massachusetts Institute of Technology.
- [17] Arco, L. J., & Abrams, E. M. (2006). An essay on energetics: the construction of the Aztec chinampa system. *Antiquity*, 80(310), 906–918. <https://doi.org/10.1017/S0003598X00094503>
- [18] Mollison, B. (2004). *Permaculture: A designers' manual*, 2nd edn. Tyalgum, Australia: Tagari.
- [19] Morehart, C. T. (2012). Mapping ancient chinampa landscapes in the basin of Mexico: A remote sensing and GIS approach. *Journal of Archaeological Science*, 39(7), 2541–2551. <https://doi.org/10.1016/j.jas.2012.03.001>
- [20] Lewis, W., & Morris, D. P. (1986). Toxicity of nitrite to fish: A review. *Transactions of the American Fisheries Society*, 115, 183–195. [https://doi.org/10.1577/1548-8659\(1986\)115<183:TONTF>2.0.CO;2](https://doi.org/10.1577/1548-8659(1986)115<183:TONTF>2.0.CO;2)
- [21] Rakocy, J. E. (1994). Aquaponics: The integration of fish and vegetable culture in recirculating systems. In *Caribbean Food Crops Society 30th Annual Meeting, 1994*, 1912–2017. <https://doi.org/10.22004/ag.econ.258746>
- [22] Sneed, K., Allen, K., & Ellis, J. E. (1975). Fish farming and hydroponics. *Aquaculture and the Fish Farmer*, 2, 11–20.
- [23] Zweig, R. D. (1986). An integrated fish culture hydroponic vegetable production system. *Aquaculture Magazine*, 12(3), 34–40.
- [24] Ako, H. (2014). How to build and operate a simple small-to-large scale aquaponics system [Working paper]. *Center for Tropical and Subtropical Aquaculture (CTSA)*. College of Tropical Agriculture and Human Resources, University of Hawaii At Manoa. https://www.ctsa.org/files/publications/CTSA_aquaponicsHowTo.pdf
- [25] Rakocy, J. E., Bailey, D. S., Shultz, R. C., & Danaher, J. J. (2011). A commercial-scale aquaponic system developed at the University of the Virgin Islands. In *Proceedings of the 9th International Symposium on Tilapia in Aquaculture*, 336–343.
- [26] Blidariu, F., & Grozea, A. (2011). Increasing the economical efficiency and sustainability of indoor fish farming by means of aquaponics-Review. *Scientific Papers Animal Science and Biotechnologies*, 44(2), 1–8.
- [27] Brooke, N. (2018). *Aquaponics for beginners: How to build your own aquaponic garden that will grow organic vegetables*. United States: Independently Published.
- [28] Rakocy, J. E., Masser, M. P., & Losordo, T. M. (2006). Recirculating aquaculture tank production systems: Aquaponics—Integrating fish and plant culture. *SRAC Publication*, 454, 1–16.
- [29] Rahmatullah, R., Das, M., & Rahmatullah, S. M. (2010). Suitable stocking density of tilapia in an aquaponic system. *Bangladesh Journal of Fish Resources*, 14(1–2), 29–35.

- [30] Thorarinsdottir, R. I., Kledal, P. R., Skar, S. L. G., Sustaeta, F., Ragnarsdóttir, K. V., Mankasingh, U., . . . , & Shultz, C. (2015). *Aquaponics guidelines*. Iceland: Haskolaprent, Reykjavik.
- [31] Jangra, M., Dahiya, T., & Kumari, A. (2022). *Aquaponics: An integration of agriculture and aquaculture*. Recent Advances in Agriculture. Germany: Weser Books. <https://doi.org/10.33545/wb.book.210>
- [32] Goddek, S., Joyce, A., Kotzen, B., & Burnell, G. M. (2019). *Aquaponics food production systems: Combined aquaculture and hydroponic production technologies for the future*. Cham, Switzerland: Springer Nature. <http://doi.org/10.1007/978-3-030-15943-6>
- [33] Government of the Republic of Trinidad and Tobago. (2023). *Agriculture sector: Investment incentives for the agriculture sector*. Retrieved from: <https://info.tbizlink.gov.tt/investment-incentives/agriculture>

How to Cite: Charles, D. (2023). Aquaponics for Trinidad and Tobago: Advancing Sustainable Farming for Low-Carbon Economy. *Green and Low-Carbon Economy*. <https://doi.org/10.47852/bonviewGLCE32021075>